

Hyperspectral Imager for the Coastal Ocean (HICO) Performance Testing and Calibration HICO User Group (HUG)

Daniel R Korwan, Robert. L. Lucke, Michael R Corson,
Rong-Rong Li

February 22, 2011



HICO Requirements

Parameter	Requirement
Off-nadir pointing	45 deg port, 30 deg starboard
Spectral Range	400 to 860 nm (goal 380 to 1000 nm)
Spectral Channel Width (normal mode)	10 nm (goal 5 nm)
Spectral Channel Width (HR mode)	No requirement
Signal to Noise Ratio	> 200 to 1 for a 5% surface albedo (10 nm spectral bins)
Polarization Sensitivity	< 5% (goal < 2%)
Crosstrack Ground Sample Distance	100 m @ 400 km alt.
Along-track Ground Sample Distance	100 meters
Scene Size	(50 km wide)×(200 km long)
vignetting	No vignetting
Saturation	Will not saturate when viewing 95% albedo cloud
Image quality	MTF > 0.35 at Nyquist spatial frequency of 0.5 cycles/pixel
Spectral stray light	< 1% albedo error
Jitter	< 0.2 IFOV per frame
Long term stability	+/- 5% after calibration



- Characterization
 - Smile (rotation)
 - Keystone
 - Spectral alignment (PSF)
 - Spatial alignment (PSF)
 - Spectral calibration
 - Pointing (no slides)
 - Polarization

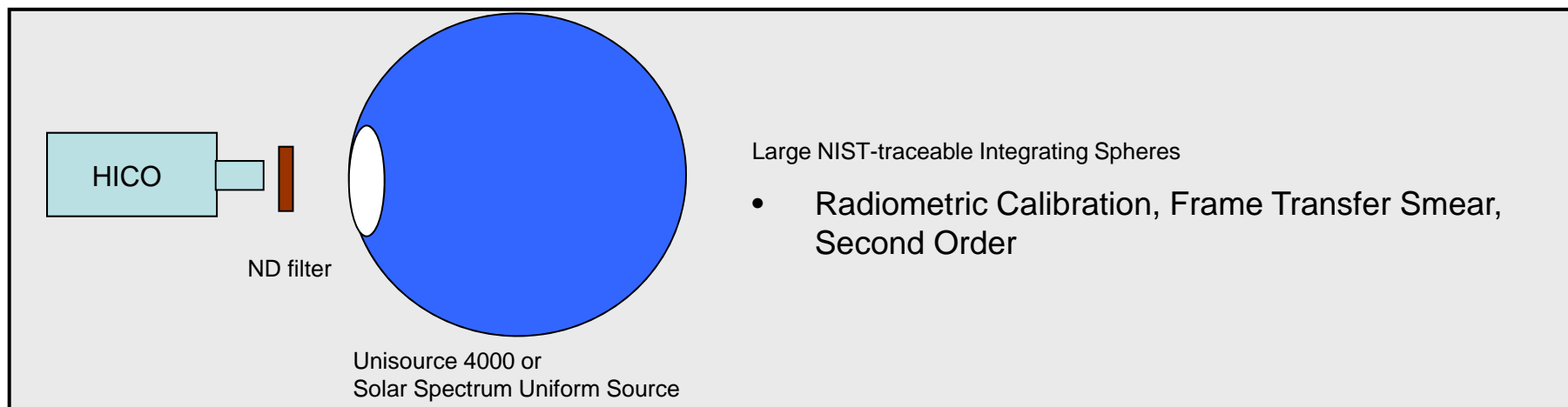
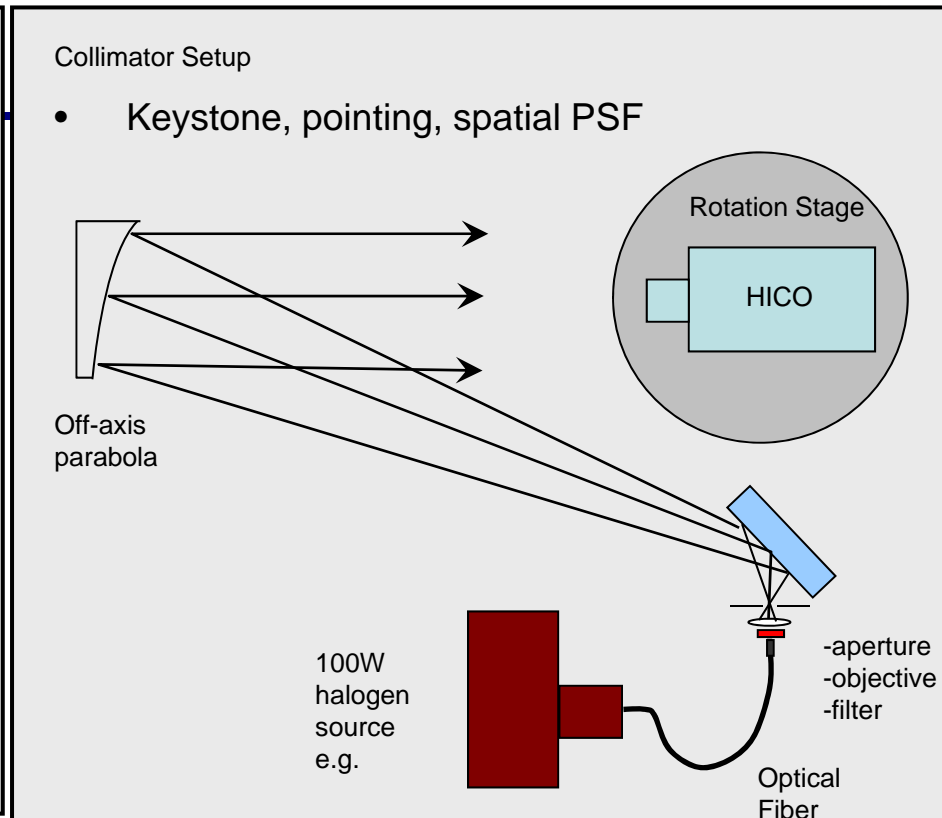
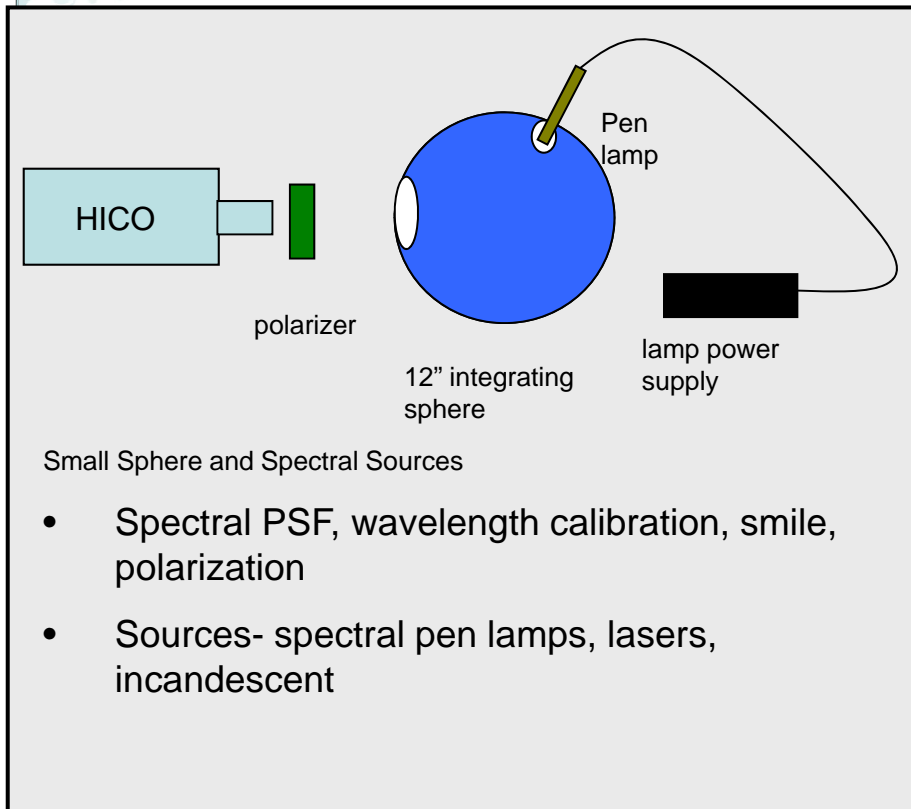

HICO Smile and Keystone

(real data from thermal vacuum testing)



← 512 spatial samples →

128 bands

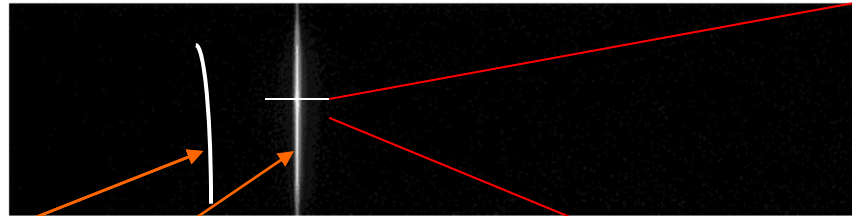

Continuum Source

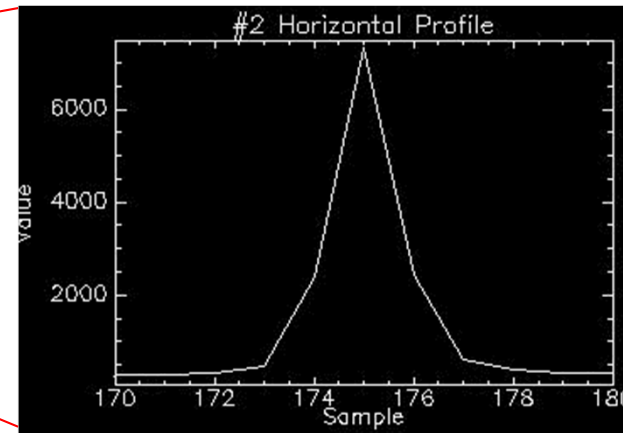

Keystone example

Real data

384 wavelength bands

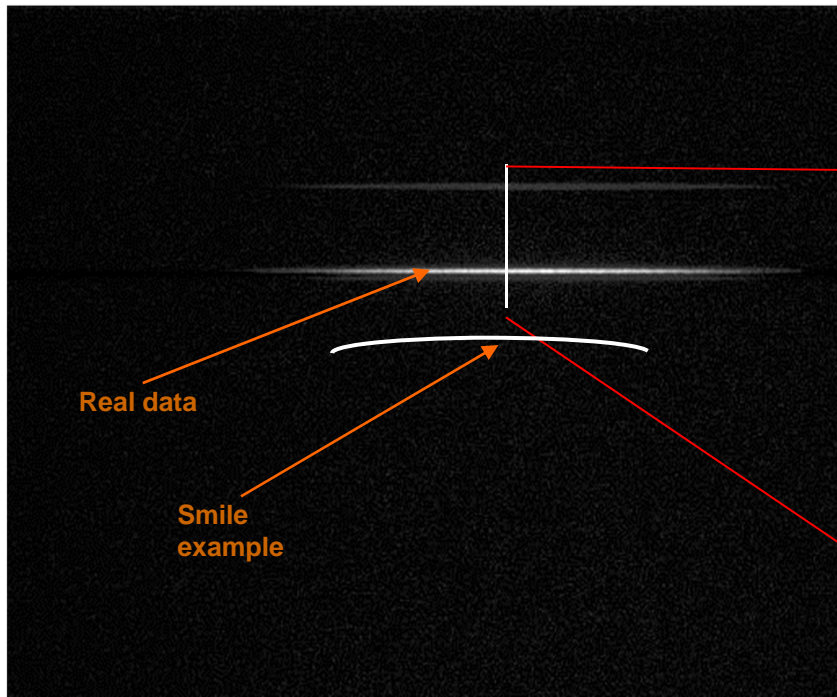

Laser Sources

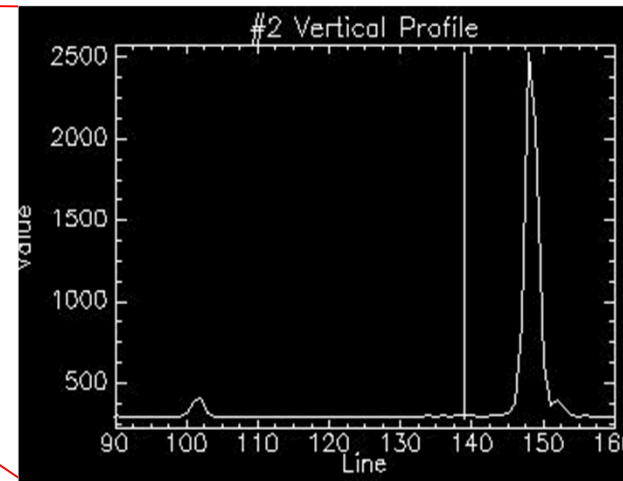

Smile

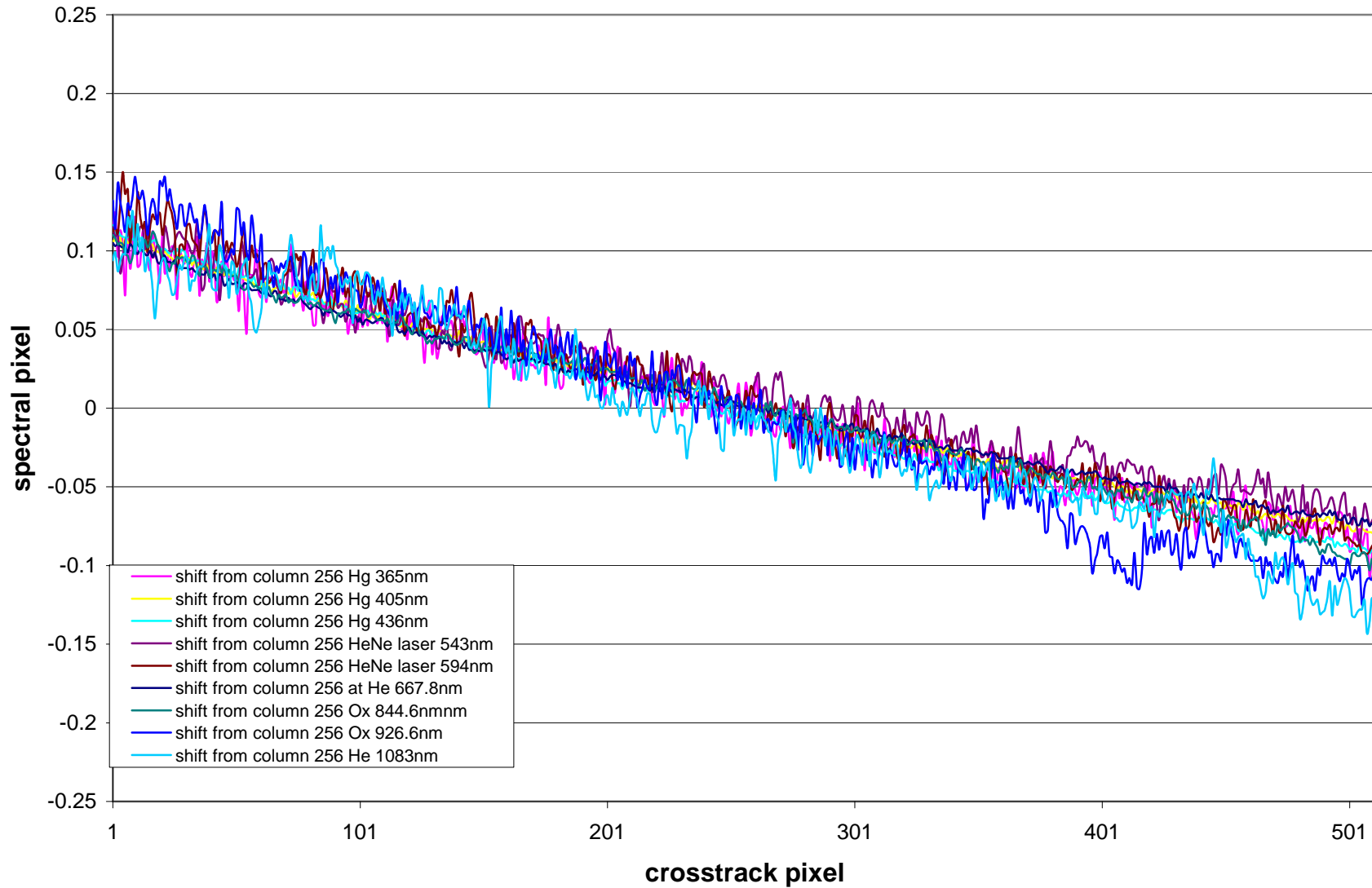

Spectral Channel Widths

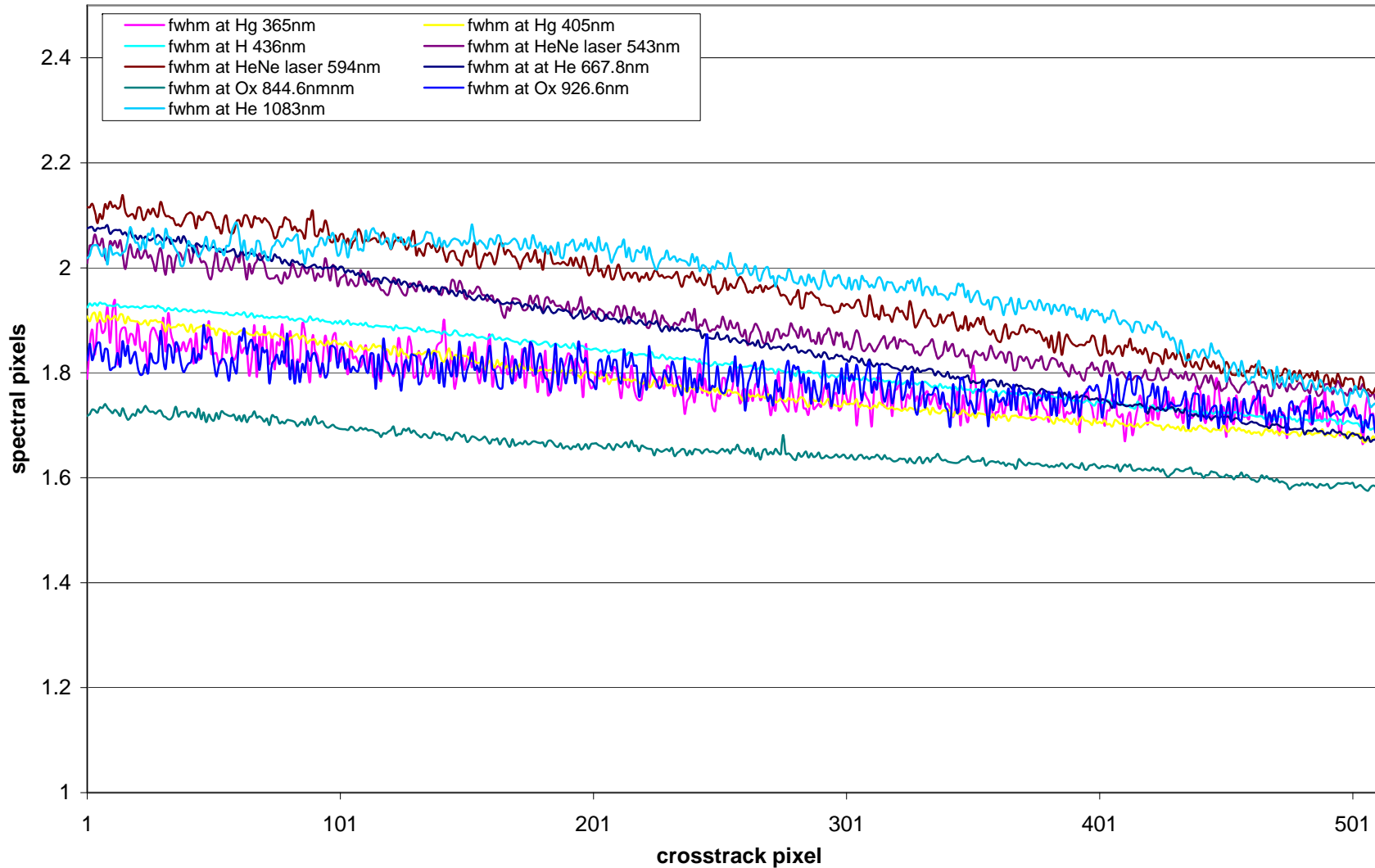

Wavelength Shift

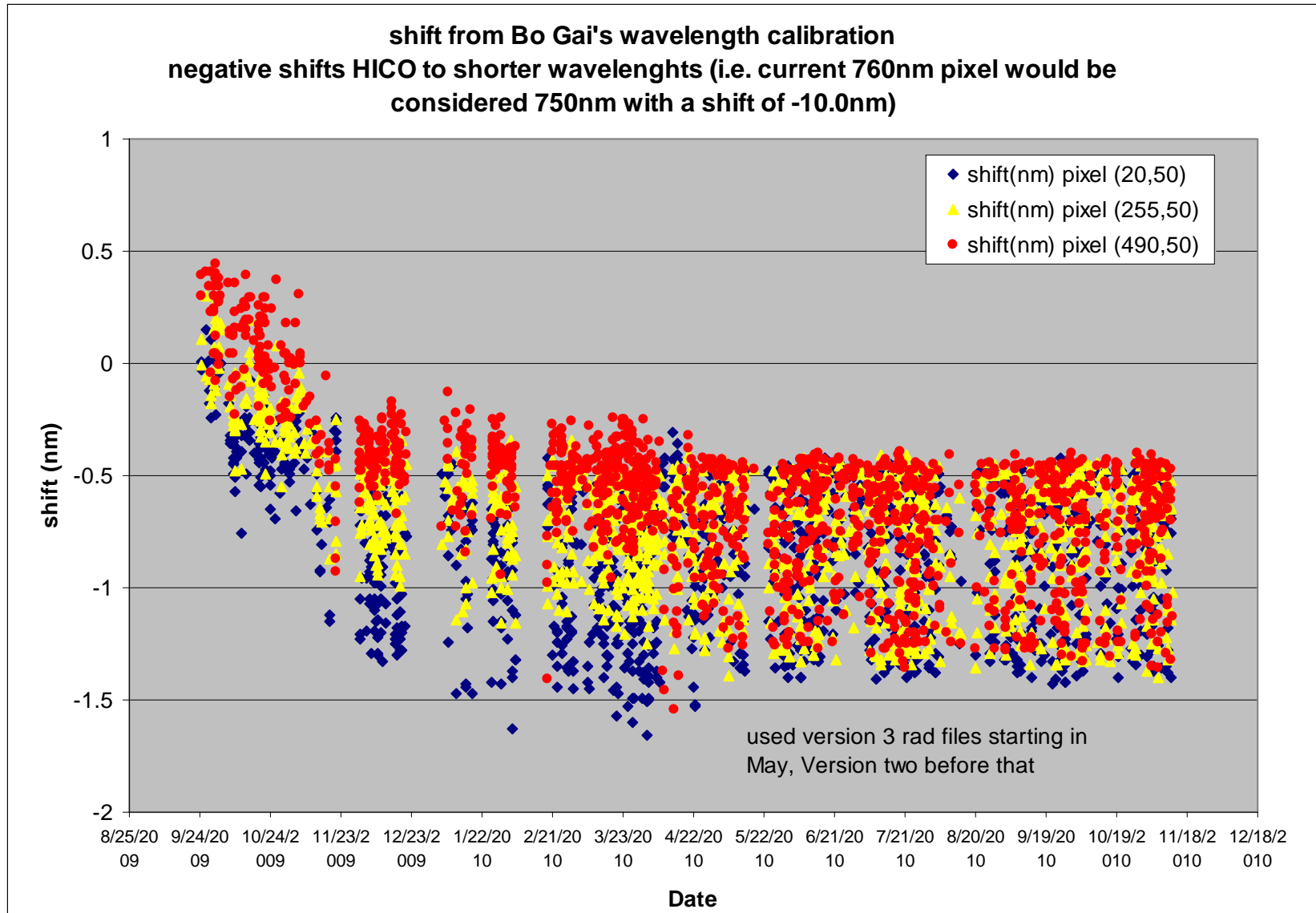

Spatial Alignment

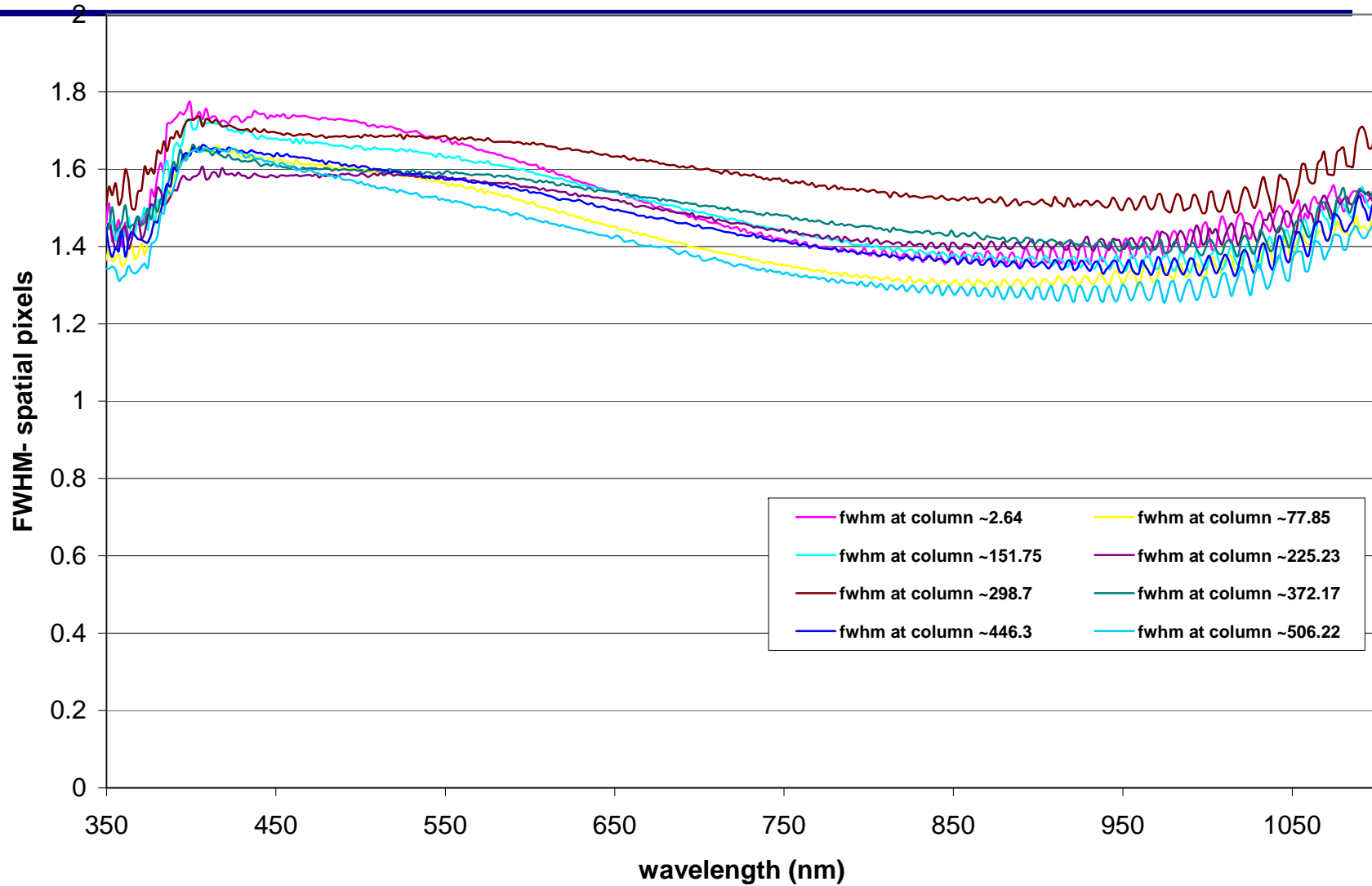

Keystone- spatial shift from 631nm band

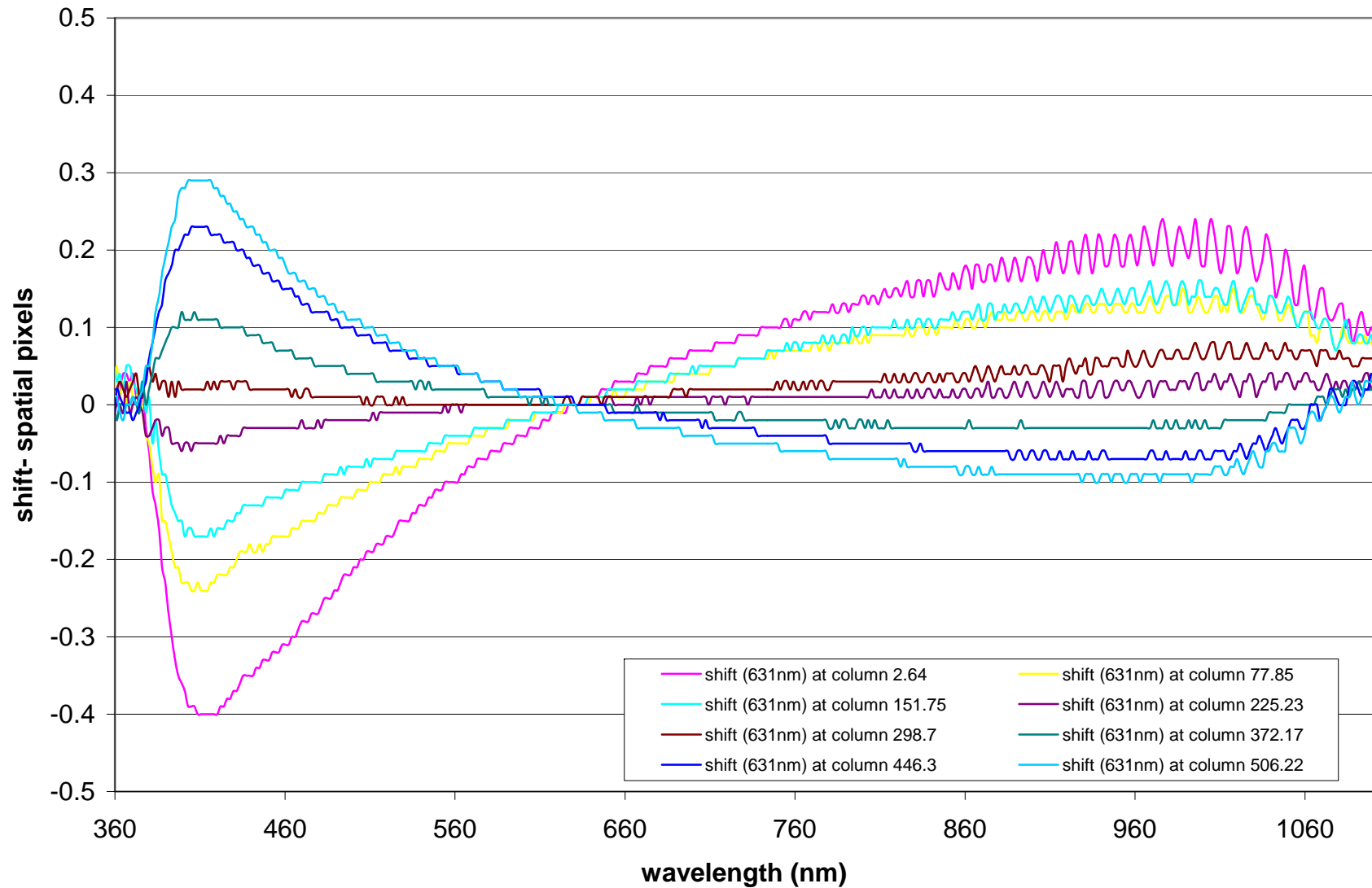

Polarization Sensitivity

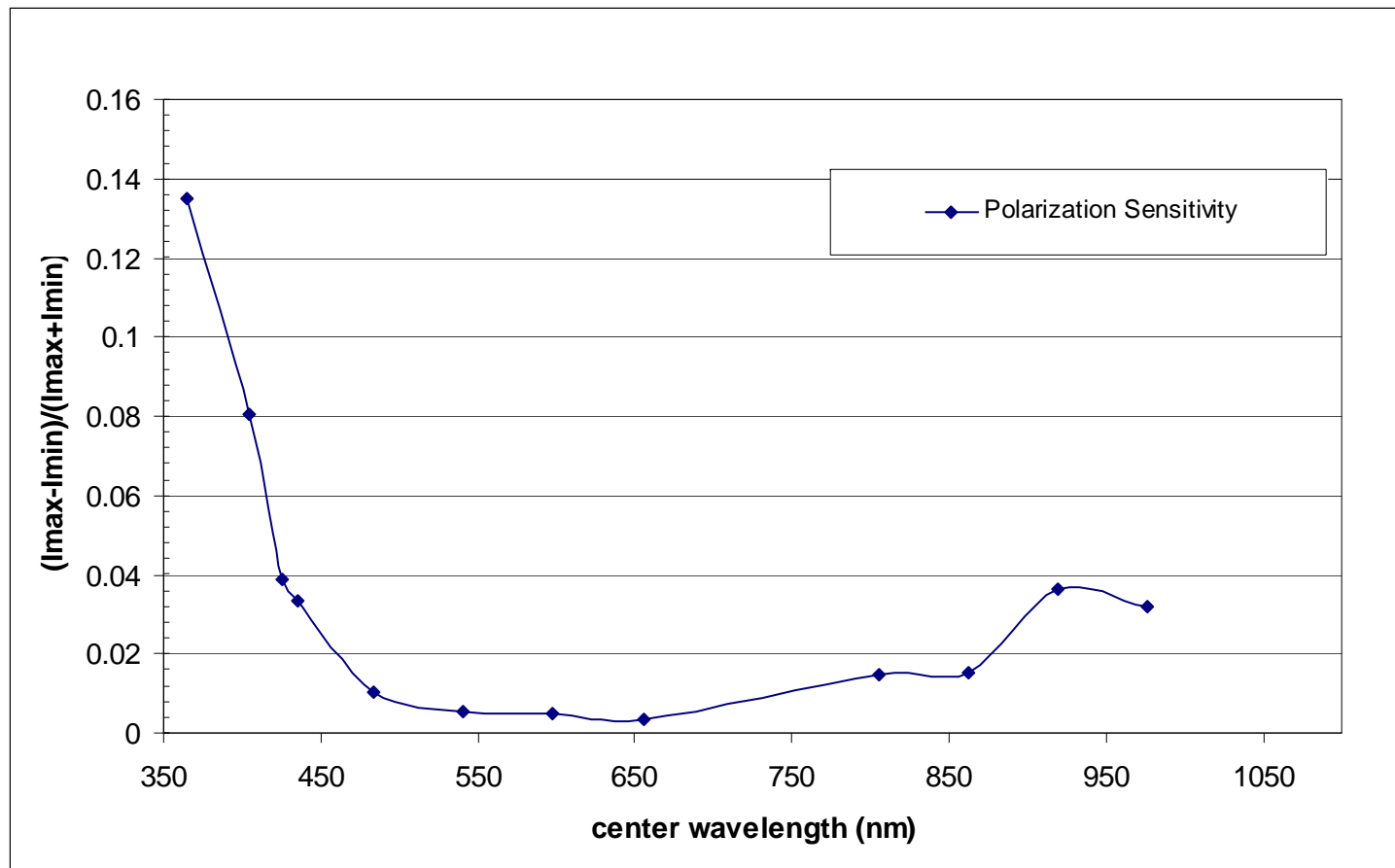



- Radiometrics
 - Calibration
 - Dark current
 - Frame transfer smear (no slides here)
 - Second order
 - Confirm model
 - SNR

Correcting Dark Counts

- As CCD Warms Up, Dark Counts Increase
- Use Leading and Trailing Dark Frames to Correct Scene Frames
- Works Well on first Data Examined

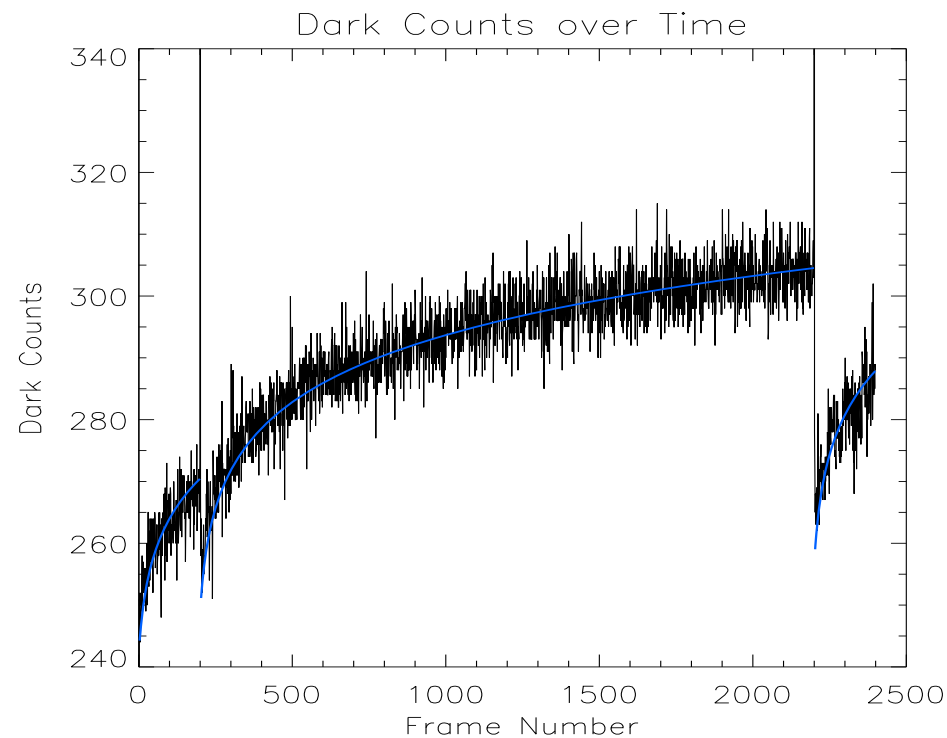

Dark Current



Dark Current varies over course of scene

Use dark collection before scene to model scene dark

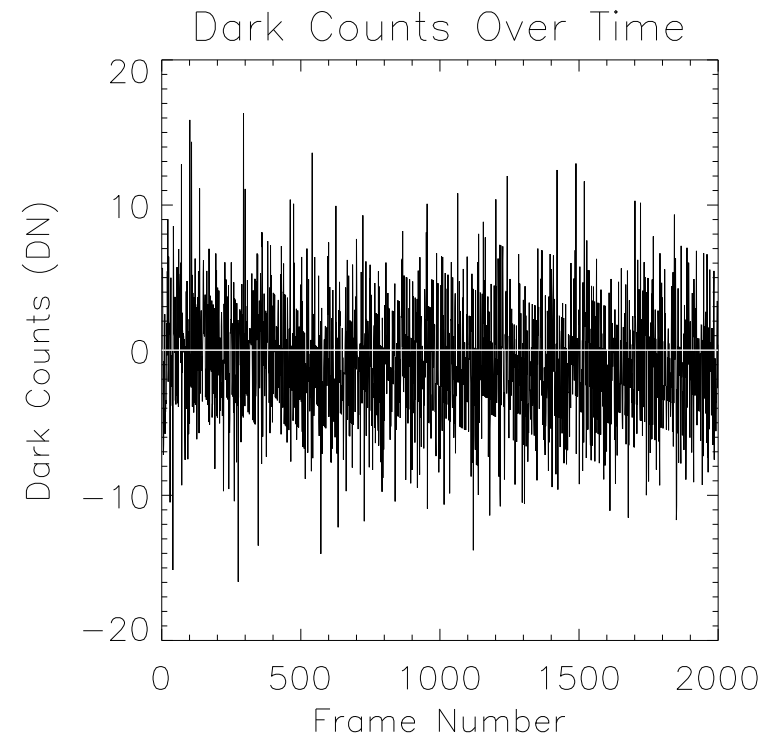
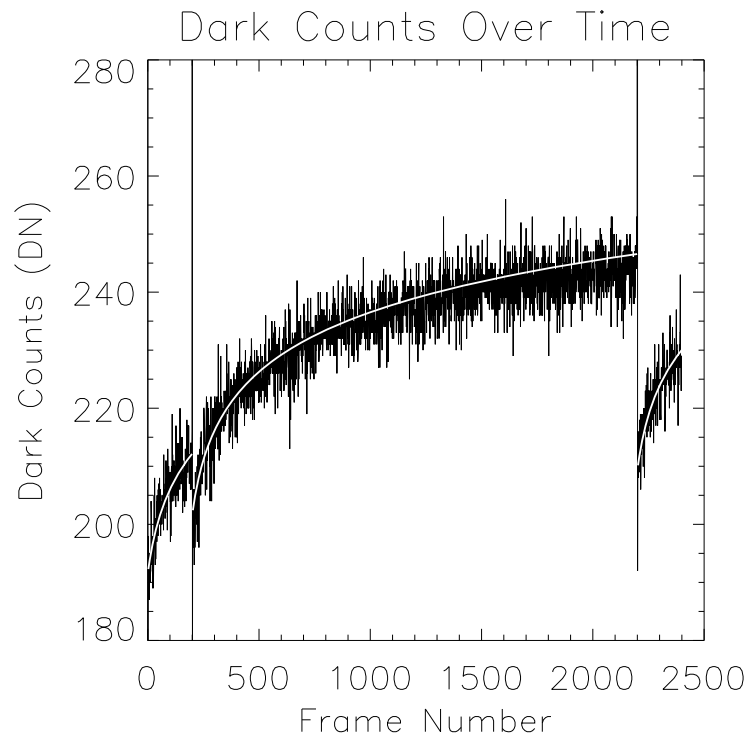

2nd Order Light



- HICO does not have an order sorting filter so second order light must be accounted for
- This has been modeled in PC Grate as well as measured in the lab

Efficiency of 1.068 deg grating Unpolarized input

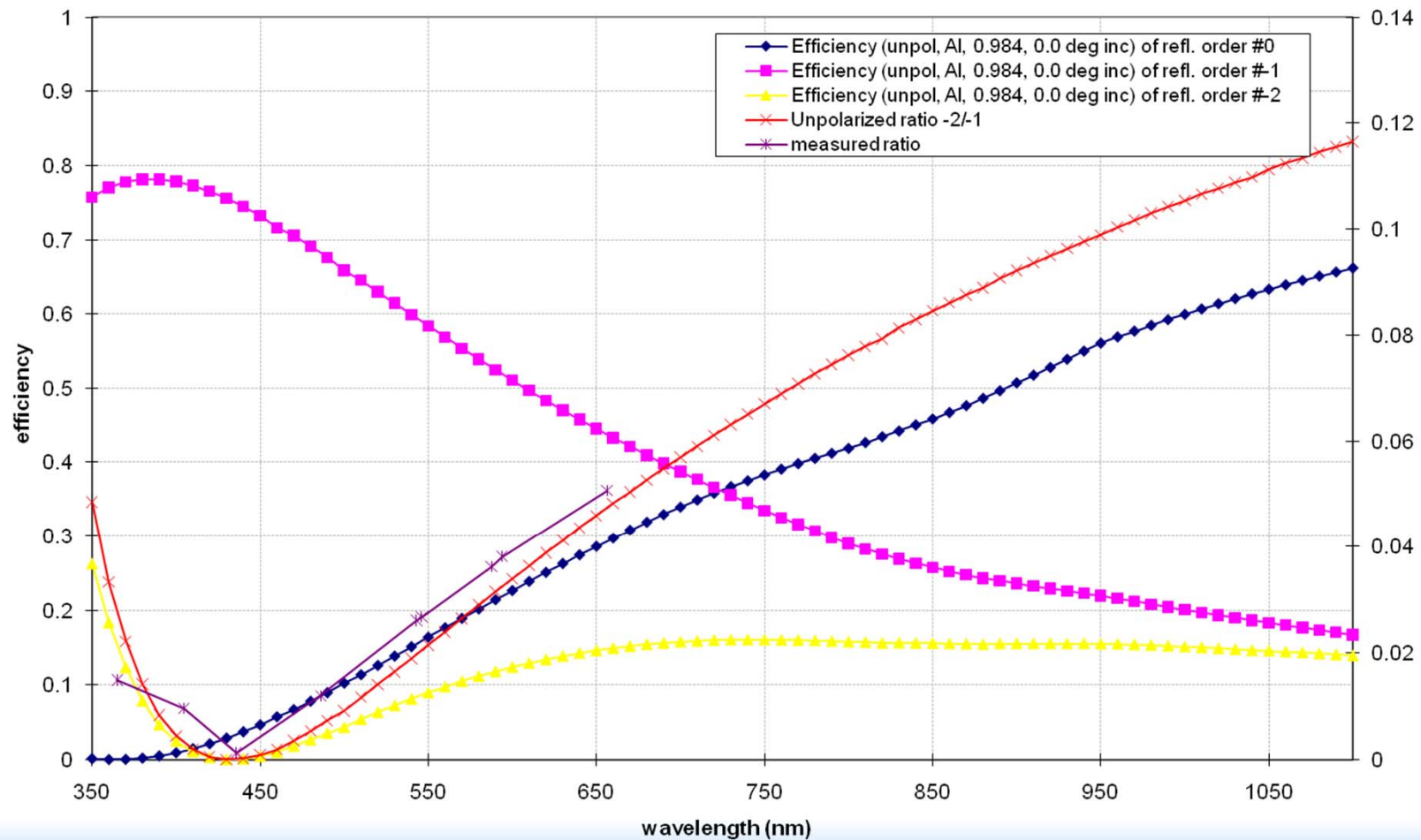

HICO Responsivity – Model and Laboratory



HICO measured response to known integrating sphere source compared to model

(DN = Digital Numbers, Correction is for smear and second order)

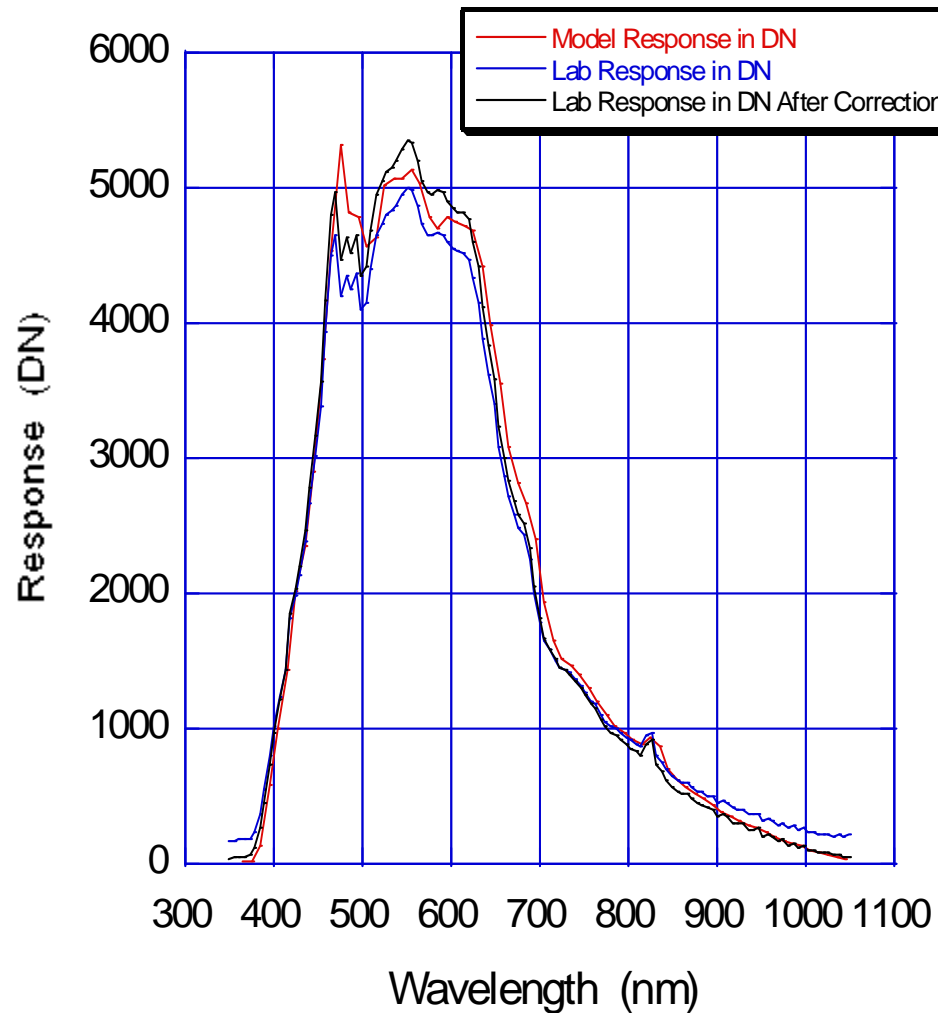

Integrating sphere sources
in calibration laboratory

Blue Sphere Scene modeling

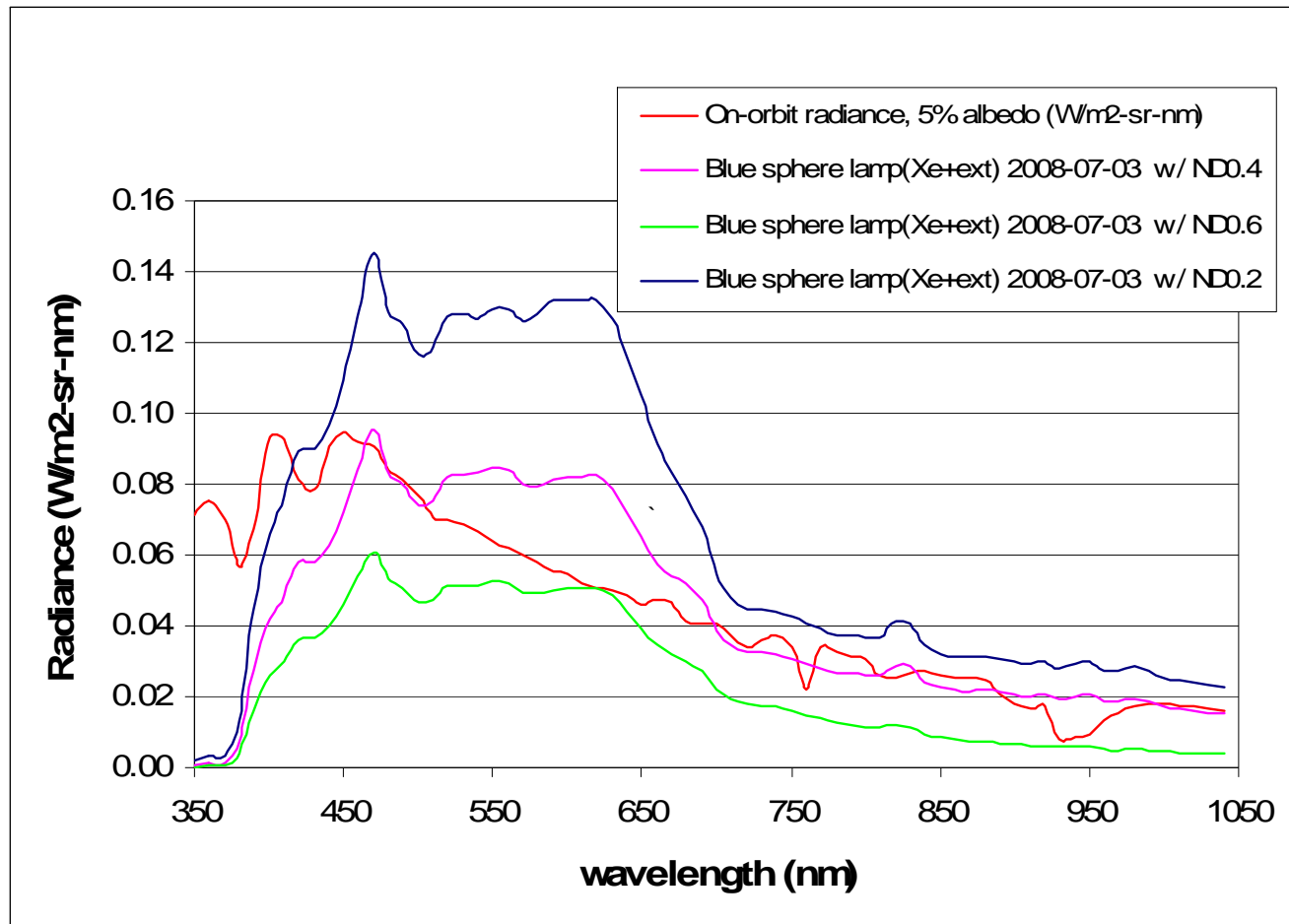

Measured SNR

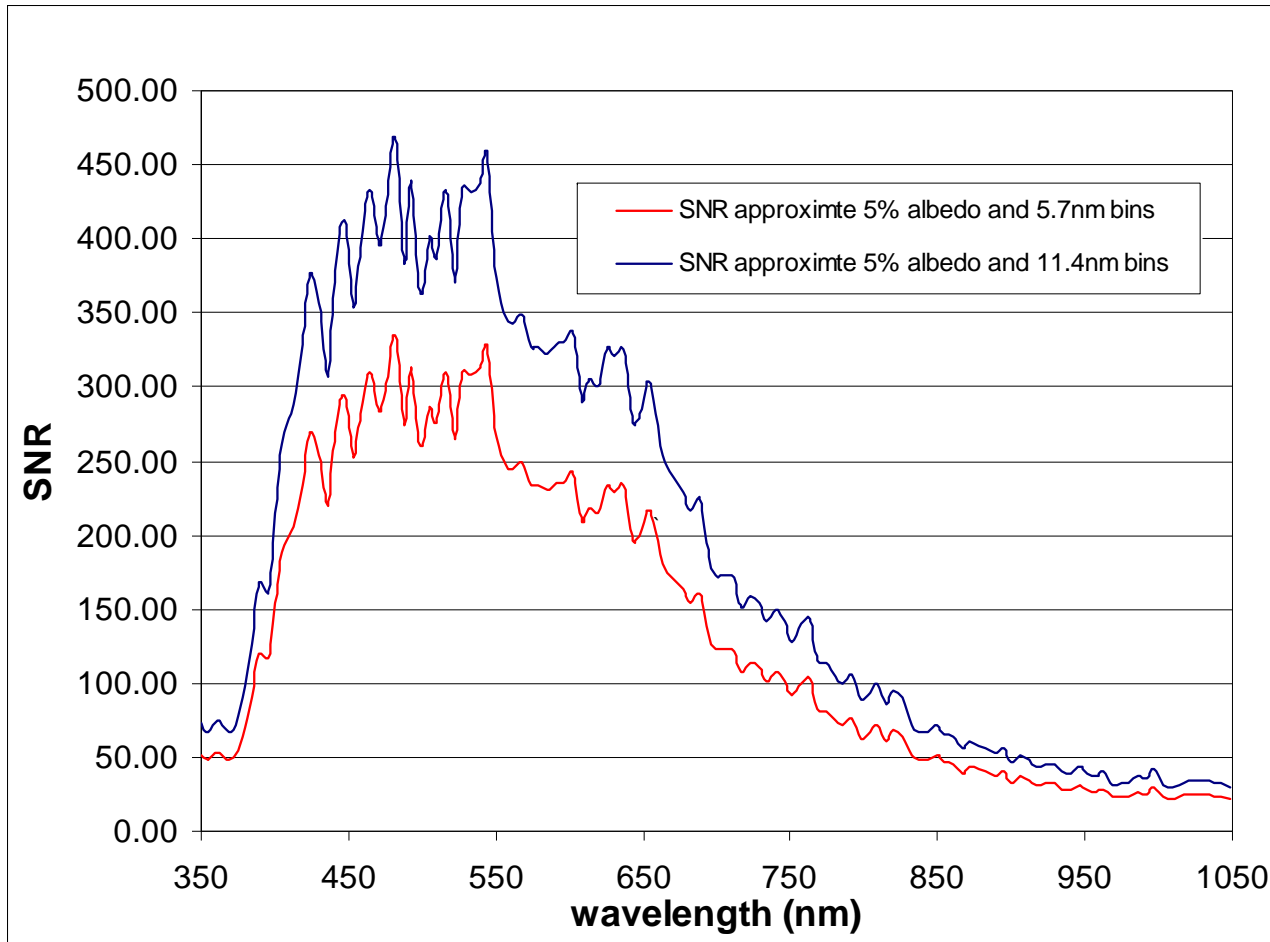



- HICO looked pretty good on the ground
 - Meets or exceeds SNR requirements
 - Meets or exceeds alignment requirements
 - Radiometric model confirmed
 - Small polarization effect at shortest wavelengths
 - Some post launch shifts